

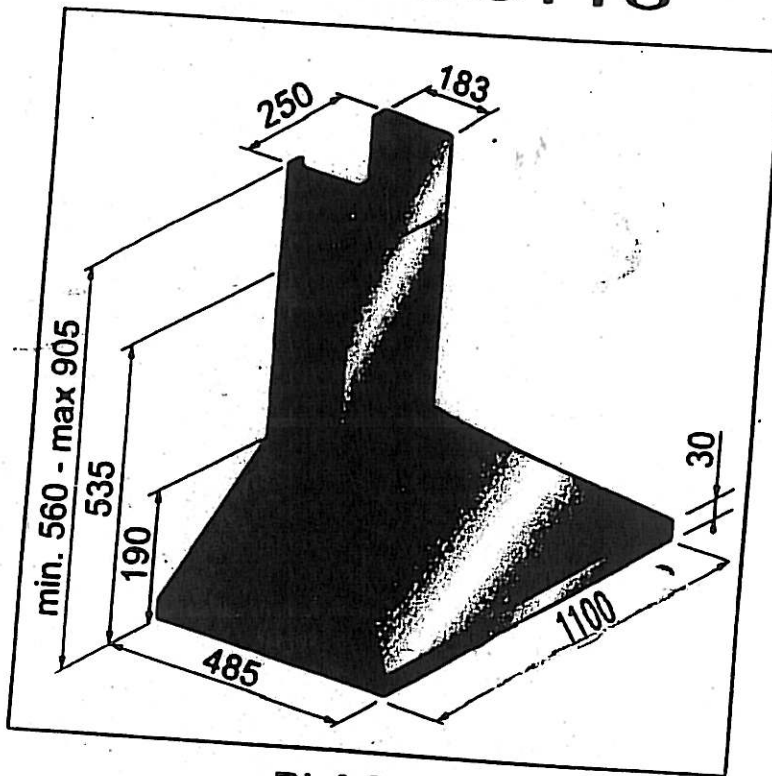

GLEN DIMPLEX
AUSTRALIA PTY LTD

GDA CB110



BLACK

type of wall (e.g. reinforced concrete, plasterboard, etc.). If the screws and screw anchors are provided with the product, check that they are suitable for the type of wall on which the hood is to be fixed.

• Fixing the decorative telescopic flue

Arrange the electrical power supply within the dimensions of the decorative flue. If your appliance is to be installed in the ducting version or in the version with external motor, prepare the air exhaust opening. Adjust the width of the support bracket of the upper flue (Fig.3). Then fix it to the ceiling using the screws **A** (Fig.3) in such a way that it is in line with your hood and respecting the distance from the ceiling indicated in Fig.2. Connect the flange **C** to the air exhaust hole using a connection pipe (Fig.4). Insert the upper flue into the lower flue and rest above the frame. Extract the upper flue up to the bracket and fix it with the screws **B** (Fig.3). To transform the hood from a ducting version into a filtering version, ask your dealer for the charcoal filters and follow the installation instructions.

• Filtering version

Install the hood and the two flues as described in the paragraph for installation of the hood in ducting version. To assemble the filtering flue refer to the instructions contained in the kit. If the kit is not provided, order it from your dealer as accessory. The filters must be applied to the suction unit positioned inside the hood. They must be centred by turning them 90 degrees until the stop catch is tripped (fig. 7).

USE AND MAINTENANCE

• We recommend that the cooker hood is switched on before any food is cooked. We also recommend that the appliance is left running for 15 minutes after the food is cooked, in order to thoroughly eliminate all contaminated air.

The effective performance of the cooker hood depends on constant maintenance: the anti-grease filter and the active carbon filter both require special attention.

• **The anti-grease filter** is used to trap any grease particles suspended in the air, therefore is subject to saturation (the time it takes for the filter to become saturated depends on the way in which the appliance is used).

- To prevent potential fire hazards, the anti-grease filters should be washed a minimum of every 2 months (it is possible to use the dishwasher for this task).

- After a few washes, the colour of the filters may change. This does not mean they have to be replaced.

If the replacement and washing instructions are not followed, the anti-grease filters may present a fire hazard.

• **The active carbon filters** are used to purify the air which is released back into the room. The filters are not washable or re-usable and must be replaced at least once every four months.

The active carbon filter saturation level depends on the frequency with which the appliance is used, the type of cooking performed and the regularity with which the anti-grease filters are cleaned.

• Clean the cooker hood frequently, both inside and outside, using a cloth which has been dampened with denatured alcohol or neutral, **non-abrasive** liquid detergents.

• The light on the cooker hood is designed for use during cooking and not for general room illumination. Extended use of the light reduces the average duration of the bulb.

• **Commands:** (fig.5) **luminous** the key symbols are explained below:

A = LIGHT

B = OFF

C = SPEED I

D = SPEED II

E = SPEED III

F = AUTOMATIC STOP TIMER - 15 minutes

• If your appliance does not have the **INTENSIVE** speed function, press key **E** for two seconds and it will be activated for 10 minutes after which it will return to the previously set speed.

When the function is active the LED flashes. To interrupt it before the 10 minutes have expired press key **E** again.

• By pressing key **F** for two seconds (with the hood switched off) the "clean air" function is activated. This function switches the appliance on for ten minutes every hour at the first speed. As soon as this function is activated the motor starts up at the first speed for ten minutes. During this time key **F** and key **C** must flash at the same time.

After ten minutes the motor switches off and the LED of key **F** remains switched on with a fixed light until the motor starts up again at the first speed after fifty minutes and keys **F** and **C** start to flash again for ten minutes and so on.

By pressing any key for the exclusion of the hood light the hood will return immediately to its normal functioning (e.g. if key **D** is pressed the "clean air" function is deactivated and the motor moves to the 2nd speed straight away. By pressing key **B** the function is deactivated).

• Active carbon/grease filter saturation:

- When button **A** flashes at a frequency of **2 seconds**, the **grease** filters must be cleaned.

- When button **A** flashes at a frequency of **0.5 seconds**, the **carbon** filters must be replaced.

After the clean filter has been replaced, the electronic memory must be reset by pressing button **A** for approximately **5 seconds**, until the light on the button stops flashing.

• **Commands:** (fig.9A-C) **mechanical** (fig.9B) **elliptic** the key symbols are explained below:

A = LIGHT

B = OFF

C = SPEED I

D = SPEED II

E = SPEED III

G = MOTOR WORKING indicator

• **Commands:** (pic.8) **slider** the key symbols are explained below:

A = Light switch

A1 = Off key

A2 = On key

B = Gemma warning light key

C = Speed control

C1 = Off key

C2 = FIRST SPEED key

C3 = SECOND SPEED key

C4 = THIRD SPEED key

THE MANUFACTURER DECLINES ALL RESPONSIBILITY FOR EVENTUAL DAMAGES CAUSED BY BREACHING THE ABOVE WARNINGS.

GENERAL

Carefully read the following important information regarding installation safety and maintenance. Keep this information booklet accessible for further consultations. The appliance has been designed for use in the ducting version (air exhaust to the outside – Fig.1B), filtering version (air circulation on the inside – Fig.1A) or with external motor (Fig.1C).

SAFETY PRECAUTION

1. Take care when the cooker hood is operating simultaneously with an open fireplace or burner that depend on the air in the environment and are supplied by other than electrical energy, as the cooker hood removes the air from the environment which a burner or fireplace need for combustion. The negative pressure in the environment must not exceed 4Pa (4x10⁻⁵ bar). Provide adequate ventilation in the environment for a safe operation of the cooker hood. Follow the local laws applicable for external air evacuation.

Before connecting the model to the electricity network:

- Control the data plate (positioned inside the appliance) to ascertain that the voltage and power correspond to the network and the socket is suitable. If in doubt ask a qualified electrician.
- If the power supply cable is damaged, it must be replaced with another cable or a special assembly, which may be obtained direct from the manufacturer or from the Technical Assistance Centre.
- This device must be connected to the supply network through either a plug fused 3A or hardwired to a 2 fase spur protected by 3A fuse.

2. Warning!

In certain circumstances electrical appliances may be a danger hazard.

- A) Do not check the status of the filters while the cooker hood is operating
- B) Do not touch bulbs or adjacent areas, during or straight after prolonged use of the lighting installation.
- C) Flambé cooking is prohibited underneath the cooker hood
- D) Avoid free flame, as it is damaging for the filters and a fire hazard
- E) Constantly check food frying to avoid that the overheated oil may become a fire hazard
- F) Disconnect the electrical plug prior to any maintenance.
- G) This appliance is not intended for use by young children or infirm persons without supervision
- H) Young children should be supervised to ensure they do not play with the appliance
- I) There shall be adequate ventilation of the room when the rangehood is used at the same time as appliances burning gas or other fuels
- L) There is a risk of fire if cleaning is not carried out in accordance with the instructions

This appliance conforms to the European Directive EC/2002/96, Waste Electrical and Electronic Equipment (WEEE). By making sure that this appliance is disposed of in a suitable manner, the user is helping to prevent potential damage to the environment or to public health.

The  symbol on the product or on the accompanying paperwork indicates that the appliance should not be treated as domestic waste, but should be delivered to a suitable electric and electronic appliance recycling collection point. Follow local guidelines when disposing of waste. For more information on the treatment, re-use and recycling of this product, please contact your local authority, domestic waste collection service or the shop where the appliance was purchased.

INSTALLATION INSTRUCTIONS

Assembly and electrical connections must be carried out by specialised personnel.

• Electric Connection

The appliance has been manufactured as a class II, therefore no earth cable is necessary.

The connection to the mains is carried out as follows:

BROWN = L line

BLUE = N neutral

If not provided, connect a plug for the electrical load indicated on the description label. Where a plug is provided, the cooker hood must be installed in order that the plug is easily accessible.

An omnipolar switch with a minimum opening of 3mm between contacts, in line with the electrical load and local standards, must be placed between the appliance and the network in the case of direct connection to the electrical network.

- The minimum distance between the support surfaces of the cooking pots on the cooker top and the lowest part of the cooker hood must be at least 65 cm. If a connection tube composed of two parts is used, the upper part must be placed outside the lower part. Do not connect the cooker hood exhaust to the same conductor used to circulate hot air or for evacuating fumes from other appliances generated by other than an electrical source.

Before proceeding with the assembly operations, remove the anti-grease filter(s) (Fig.6) so that the unit is easier to handle.

- In the case of assembly of the appliance in the suction version prepare the hole for evacuation of the air.

- We recommend the use of an air exhaust tube which has the same diameter as the air exhaust outlet hole. If a pipe with a smaller diameter is used, the efficiency of the product may be reduced and its operation may become noisier.

- If your appliance has been designed for use in habitations supplied with a centralised suction device perform the following operations:

-The switch controls opening and closure of a valve using a thermoelectrical device. By placing the switch in the ON position, after a minute, the valve opens rotating 90° allowing suction of the stale air. By placing the switch in the OFF position, the valve closes after 100 seconds.

• Fixing to the wall

Drill the holes A respecting the distances indicated (Fig.2). Fix the appliance to the wall and align it in horizontal position to the wall units: When the appliance has been adjusted, definitely fix the hood using the screws A (Fig.4). For the various installations use screws and screw anchors suited to the

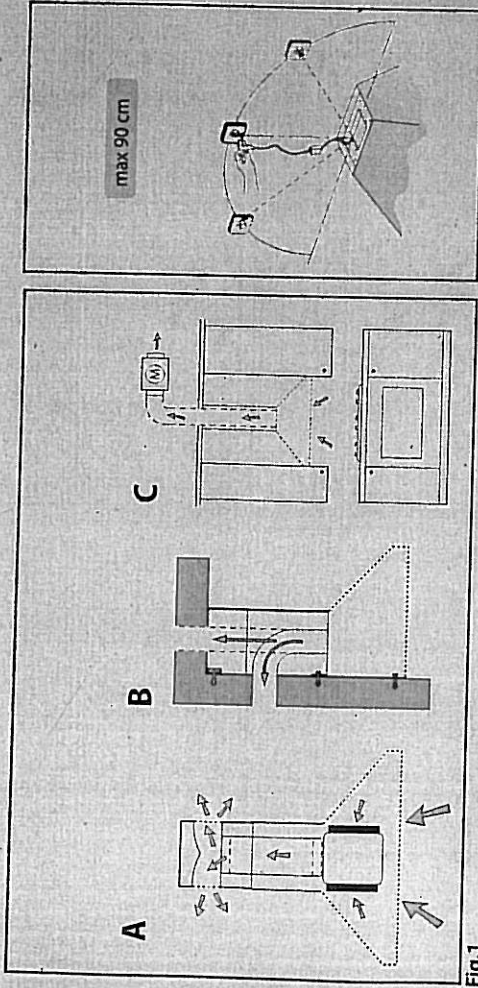

Fig. 1

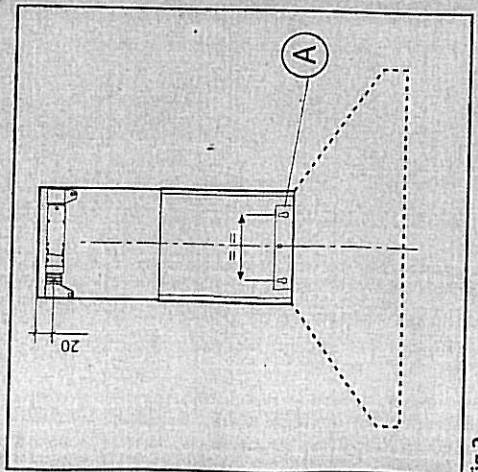

Fig. 2

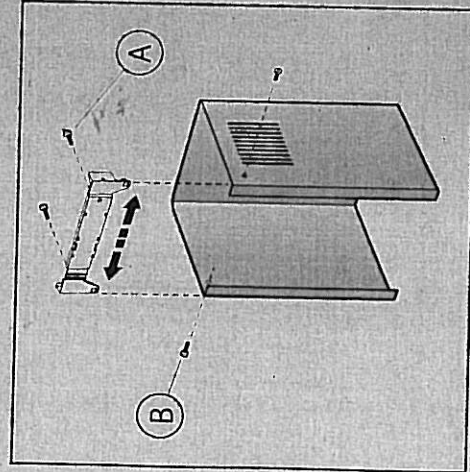

Fig. 3

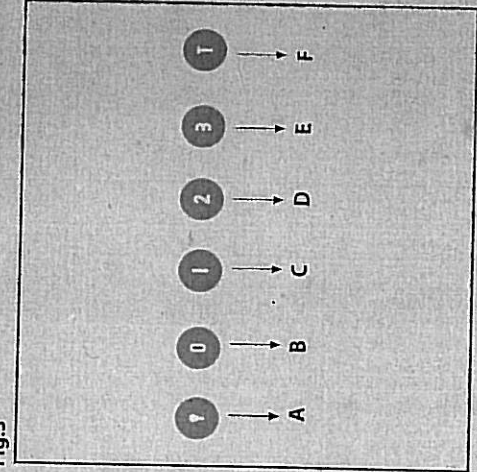

Fig. 5

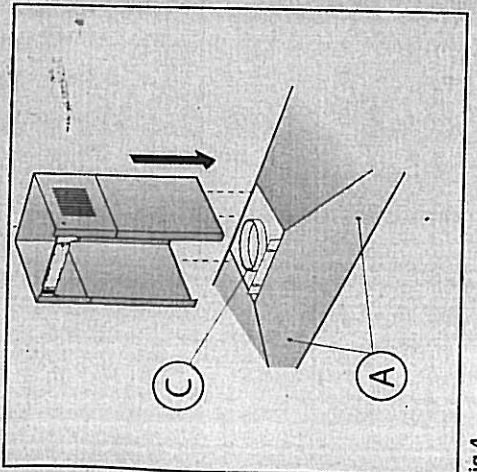

Fig. 4

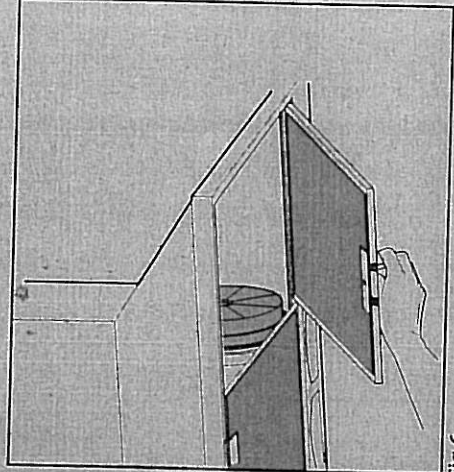

Fig. 6

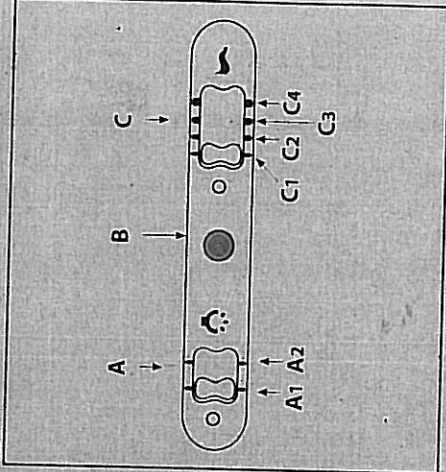

Fig. 8

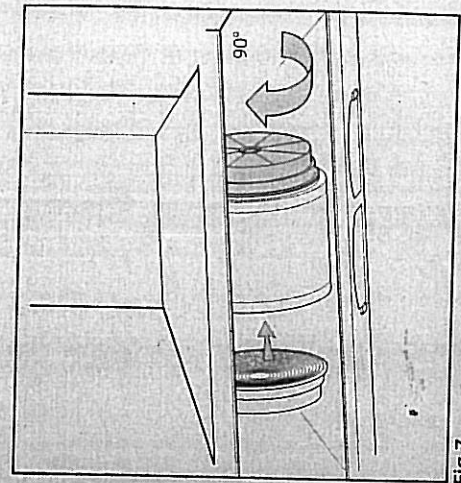

Fig. 7

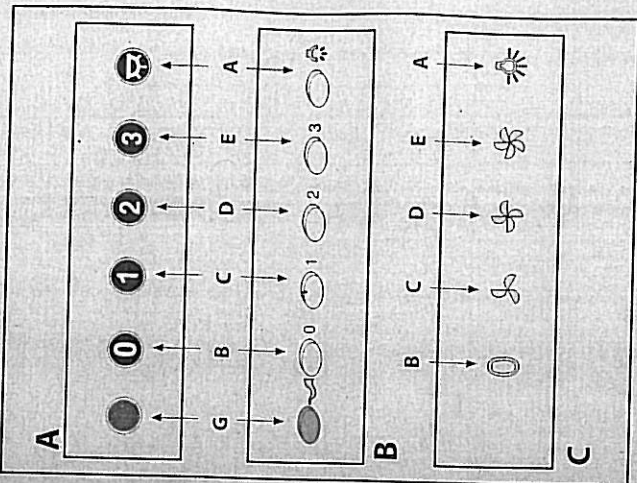

Fig. 9

